



BTZ-42418-2ERR

SPECIFICATIONS



- TYPE:** ----- DIGITAL and ALPHANUMERIC
- DISPLAY:** ----- 4-DIGIT, 7 seg. **TIME** in **RED** and 15 Char. 5x7 Dot-Matrix **LOCATION** in **RED**
- CHARACTER HEIGHT:** ----- 1.8" (45.72 mm) HR / MIN and 0.7" (17.78mm) LOCATION
- VISIBILITY:** ----- 50 Ft. (15.2 METERS)
- POWER REQUIREMENTS:** --- 100-240V 50~60Hz (**12vdc Switching Power Supply**).
- FRAME:** ----- ALUMINUM (BLACK ANODIZED FINISH)
- DIMENSIONS:** ----- 7.25" x 22.25" x 1.5"
- WEIGHT:** ----- 4.2 lbs.
- OPERATING TEMP.:** ----- -17° TO 190° F
- HUMIDITY:** ----- 0% TO 95% NON-CONDENSING
- OPERATING MODE:** ----- AUTOMATIC DAY LIGHT SAVINGS, 31 TIME ZONES, 10 YEAR MEMORY BACKUP WITH 1 SEC/YEAR ACCURACY, NON-GLARE LENS, EYELET AND SAW TOOTH SURFACE MOUNT, PC INTERFACE WITH DDS TIMENET 2 SOFTWARE INCLUDED AND RS232/DB-9 CABLE

ALL CLOCKS USE THE DALLAS DS32 SERIES RTC PARTS, AND OUR FIRMWARE CONTROL, TO GET THE ONE SEC A YEAR ACCURACY. **World's Most Accurate RTC**

Gold or Hot

1 SEC A YEAR ACCURATE (TCXO)

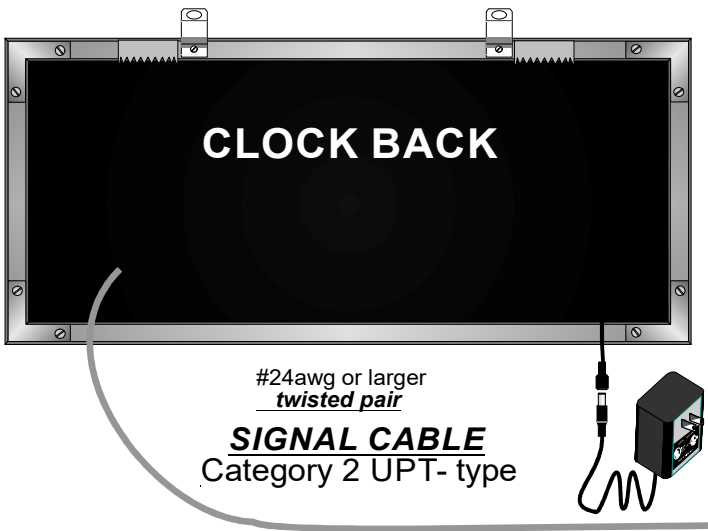

THE PC IS USED TO SET THE LOCATION DISPLAY AND TIME. THE CLOCK CAN RUN ON ITS OWN WITHOUT THE PC.

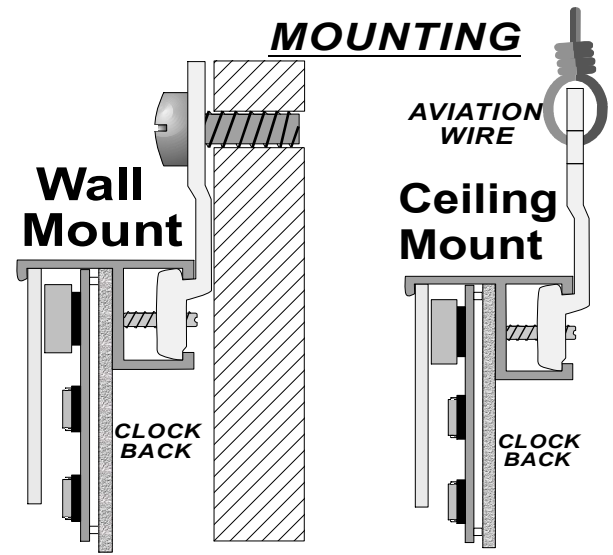
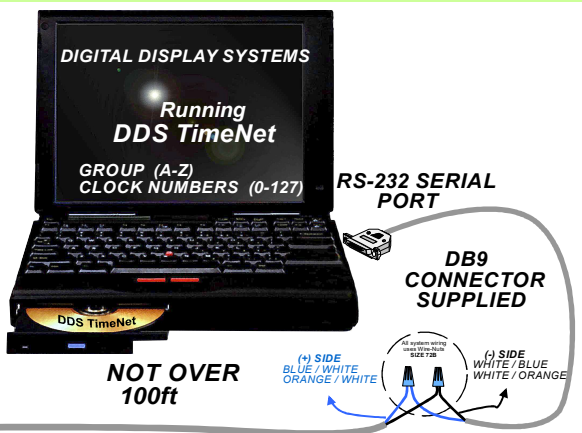



RS-232 SERIAL PORT
DB9 CONNECTOR SUPPLIED

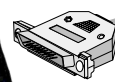
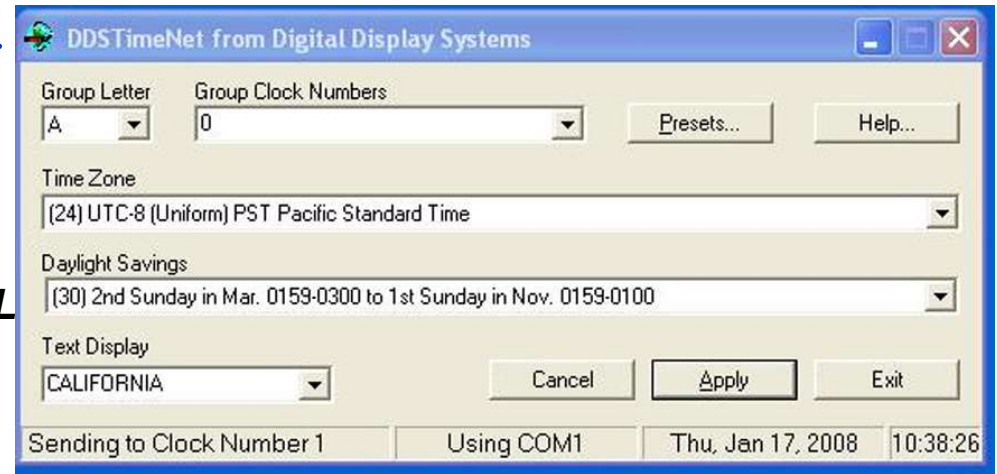

RS-232 NOT OVER 100ft

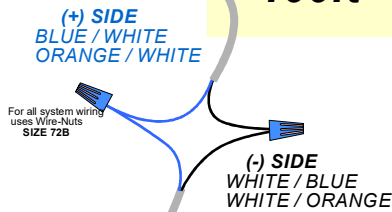

VISIBILITY CHART:

| | |
|-------------|-----------------------|
| 0.7" DIGIT: | 30 FT (9.144 Meters) |
| 1.2" DIGIT: | 50 FT (15.24 Meters) |
| 1.8" DIGIT: | 75 FT (22.86 Meters) |
| 2.0" DIGIT: | 90 FT (27.432 Meters) |
| 2.5" DIGIT: | 125 FT (38.10 Meters) |
| 4.0" DIGIT: | 225 FT (68.58 Meters) |
| 7.0" DIGIT: | 500 FT (152.4 Meters) |

GROUP CLOCK NUMBERS



COLOR OPTIONS



BTZ-42418-2ERR



BTZ-42418-2EGR

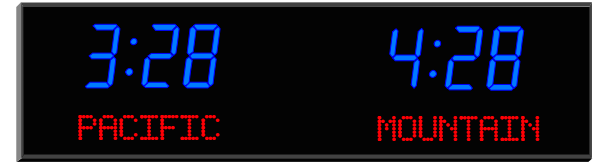

BTZ-42418-2EBR

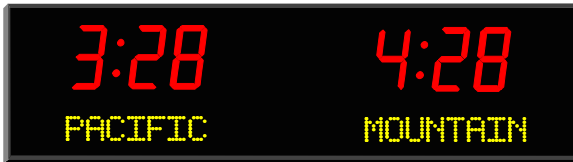

BTZ-42418-2ERY

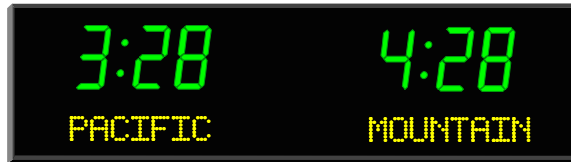

BTZ-42418-2EGY

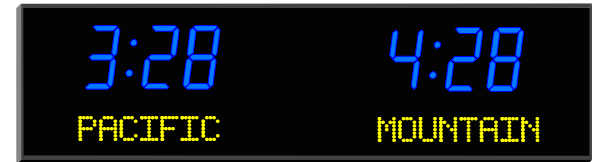

BTZ-42418-2EBY

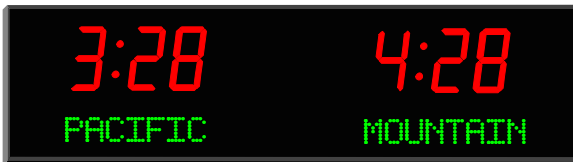

BTZ-42418-2ERG

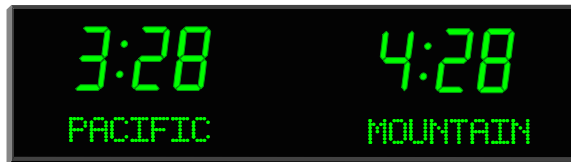

BTZ-42418-2EGG

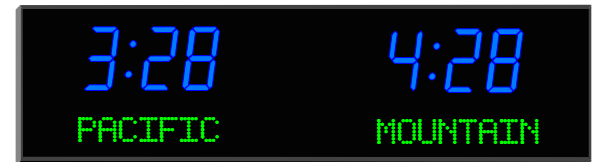

BTZ-42418-2EBG



BTZ-42418-2ERB



BTZ-42418-2EGB



BTZ-42418-2EBB